



## WINSTAR Display

# OLED SPECIFICATION

Model No:

***WEO012864JWPP3D00F00***



**SPECIFICATION**

**Version: 0**

**CUSTOMER :**

**MODULE NO. : WEO012864JWPP3D00F00**

**APPROVED BY:**

**( FOR CUSTOMER USE ONLY )**

**SALES BY**

**APPROVED BY**

**CHECKED BY**

**PREPARED BY**

**RELEASE DATE:**

**APPROVAL FOR SPECIFICATIONS ONLY**

**APPROVAL FOR SPECIFICATIONS AND SAMPLE**

**MODEL NO :**

RECORDS OF REVISION			DOC. FIRST ISSUE
VERSION	DATE	REVISED PAGE NO.	SUMMARY
0	2025/03/13		First release



# Contents

- 1.Module Classification Information
- 2.General Specification
- 3.Contour Drawing & Block Diagram
- 4.Interface Pin Function
- 5.Absolute Maximum Ratings
- 6.Electrical Characteristics
- 7.Optical Characteristics
- 8.OLED Lifetime
- 9.Reliability
- 10.Inspection specification
- 11.Precautions in use of OLED Modules

# 1. Module Classification Information

W E O 012864 J W P P 3 D 0 0 F 00  
 ① ② ③ ④ ⑤ ⑥ ⑦ ⑧ ⑨ ⑩ ⑪ ⑫ ⑬ ⑭

1	Brand : WINSTAR DISPLAY CORPORATION			
2	E : OLED			
3	Display Type	H : COB Character	G : COB Graphic	
		O : COG	F : COG + FR	
		P : COG + FR + PCB	X : COF	
		A : COG + PCB	N : COF + FR + PCB	
4	Dot Matrix : 128 * 64			
5	Serials code			
6	Emitting Color	A : Amber	R : Red	C : Full Color
		B : Blue	W : White	
		G : Green	L : Yellow	
		S : Sky Blue	X : Dual Color	
7	Polarizer	P : With Polarizer; N: Without Polarizer A : Anti-glare Polarizer		
8	Display Mode	P : Passive Matrix ; N : Active Matrix		
9	Driver Voltage	3 : 3.0~3.3V ; 5 : 5.0V		
10	Touch Panel	N : Without touch panel ; T : Resistive TP; D : CTP (Air bonding)		
11	Product type	0 : Standard		
12	Inspection Grade	0 : Standard		
13	Option	0 : Default ; E~P : Options		
14	Serial No.	Serial number(00~99)		

## 2. General Specification

Item	Dimension	Unit
Dot Matrix	128 x 64	—
Module dimension	75.0 x 52.7 x 10.2 MAX	mm
Active Area	55.01 x 27.49	mm
Pixel Size	0.40 x 0.40	mm
Pixel Pitch	0.43 x 0.43	mm
Display Mode	Passive Matrix	
Display Color	Monochrome (White)	
Drive Duty	1/64 Duty	
OLED IC	SSD1309	
OLED Interface	I2C	
Size	2.42 inch	
CTP IC	GT911	
Detect Point	1	
CTP Interface	I2C	
Surface	Normal Glare	

# 3. Contour Drawing & Block Diagram

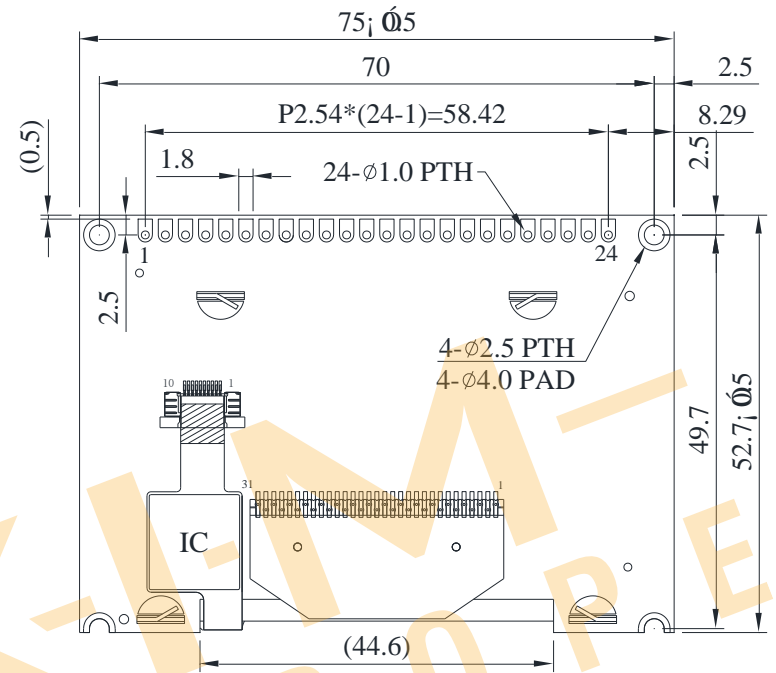
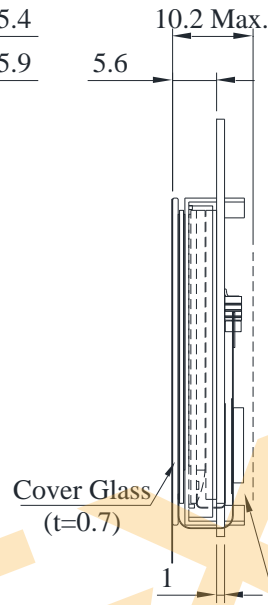
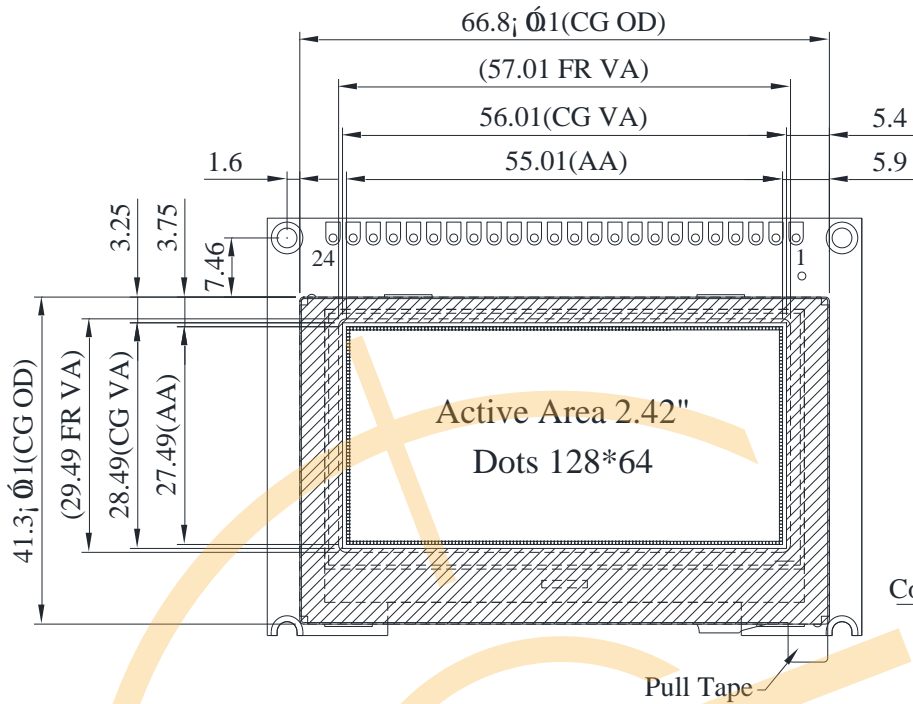

PIN	SYMBOL	PIN	SYMBOL	PIN	SYMBOL
1	VDD	9	VSS	17	VSS
2	VSS	10	VSS	18	NC
3	NC	11	VSS	19	DISP
4	SCL	12	VSS	20	NC
5	SDA	13	NC	21	TP_INT
6	NC	14	RES#	22	TP_SDA
7	VSS	15	VSS	23	TP_SCL
8	VSS	16	SA0	24	TP_RST

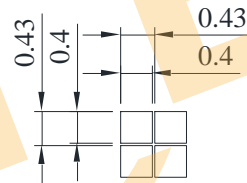

Dots Size  
 Scale 10/1

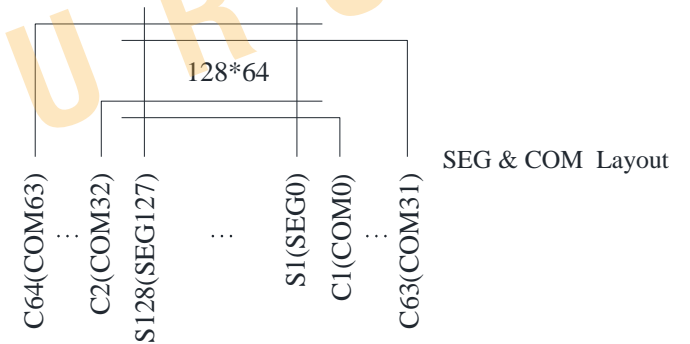

The non-specified tolerance of dimension is  $\pm 0.3$ mm.

### 3.1 Application recommendations

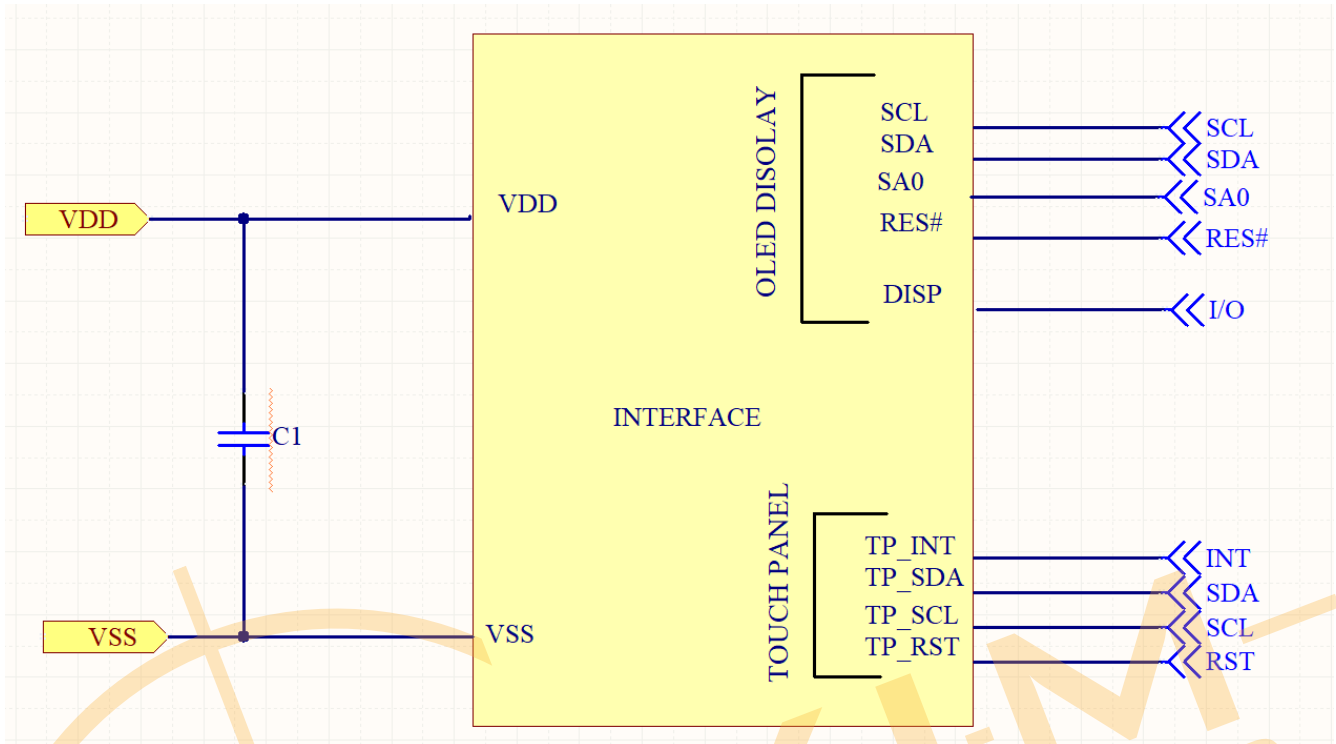

Recommended components:  
C1 : 1.0uF/16V/0603

TOUCH PANEL'S INTERFACE : ONLY I2C INTERFACE.

## 4. Interface Pin Function

No.	Symbol	Function
1	VDD	Power supply pin for core logic operation
2	VSS	Ground.
3	NC	No connection
4	SCL	The serial clock input.
5	SDA	The serial data input.
6	NC	No connection
7~12	VSS	Ground.
13	NC	No connection
14	RES#	This pin is reset signal input. When the pin is pulled LOW, initialization of the chip is executed. Keep this pin pull HIGH during normal operation.
15	VSS	Ground.
16	SA0	In I2C mode, this pin acts as SA0 for slave address selection.
17	VSS	Ground.
18	NC	No connection
19	DISP	Display off when it's pulled low; Display on when it's pulled high.
20	NC	No connection
21	TP_INT	Interrupt signal, active low, asserted to request Host start a new transaction
22	TP_SDA	I2C data signal
23	TP_SCL	I2C clock signal
24	TP_RST	External reset signal, active low

## 5. Absolute Maximum Ratings

Parameter	Symbol	Min	Max	Unit	Notes
Supply Voltage for Logic	VDD	-0.3	4	V	1, 2
Operating Temperature	TOP	-20	+70	°C	—
Storage Temperature	TSTG	-30	+80	°C	—

Note :

1. All the above voltages are on the basis of “VSS = 0V”.
2. When this module is used beyond the above absolute maximum ratings, permanent breakage of the module may occur. Also, for normal operations, it is desirable to use this module under the conditions according to Section 6 “Electrical Characteristics”. If this module is used beyond these conditions, malfunctioning of the module can occur and the reliability of the module may deteriorate.
3. The absolute limit temperature was verified according to the test conditions of reliability test (See section 9. Reliability) , and module was met all criteria.

## 6. Electrical Characteristics

### 6.1 DC Electrical Characteristics

Item	Symbol	Condition	Min	Typ	Max	Unit
Supply Voltage for Logic	VDD	—	2.8	3.0	3.3	V
High Level Input	VIH	—	0.8×VDD	—	—	V
Low Level Input	VIL	—	—	—	0.2×VDD	V
High Level Output	VOH	—	0.9×VDD	—	—	V
Low Level Output	VOL	—	—	—	0.1×VDD	V
Display 50% Pixel on	IDD	VDD =3V	—	150	300	mA

## 6.2 OLED DISPLAY's Initial code

```

void Initial_SSD1309(){

    Write_command(0xAE);        // Display Off

    Write_command(0xA8);        // Select Multiplex Ratio
    Write_command(0x3F);        // Default => 0x3F (1/64 Duty)    0x1F(1/32 Duty)

    Write_command(0xD3);        //Setting Display Offset
    Write_command(0x00);        //00H Reset

    Write_command(0x20);        //Set Memory Addressing Mode
    Write_command(0x02);        //Page Addressing Mode

    Write_command(0x00);        //Set Column Address LSB

    Write_command(0x10);        //Set Column Address MSB

    Write_command(0x40);        //Set Display Start Line

    Write_command(0xA6);        //Set Normal Display

    Write_command(0xDB);        //Set Deselect Vcomh level
    Write_command(0x3C);        //~0.83xVCC

    Write_command(0xA4);        //Entire Display ON

    Write_command(0x81);        //Set Contrast Control
    Write_command(0xAF);

    Write_command(0xD5);        //SET DISPLAY CLOCK
    Write_command(0xC0);        //105HZ

    Write_command(0xA1);        //Set Segment Re-Map Default => 0xA0
                                //0xA1 (0x01) => Column Address 0 Mapped to SEG131

    Write_command(0xC8);        //Set COM Output Scan Direction Default => 0xC0
                                //0xC8 (0x08) => Scan from COM63 to 0

    Write_command(0xDA);        //Set COM Hardware Configuration
    Write_command(0x12);        //Alternative COM Pin

    Write_command(0xD9);        //Set Pre-Charge period
    Write_command(0x22);

    Write_command(0xAF);        // Display ON
}

```

Note 1: Initial code is for reference only. Please make the best adjustment with the OLED module.

Note 2: Command: Set Contrast Control (0x81) , This command sets the Contrast Setting of the display. The chip has 256 contrast steps from 00h to FFh. The segment output current increases as the contrast step value increases. The segment current increases, the OLED brightness increases.

## 6.3 TOUCH PANEL's application code.

### 6.3.1 I2C address format

GT911 supports two I2C slave addresses: 0xBA/0xBB and 0x28/0x29.

Item	Write	Read
	Address_W	Address_R
0xBA/0xBB address	0xBA	0xBB
0x28/0x29 address	0x28	0x29

### 6.3.2 Power on for I2C address select

The host can select the address by changing the status of Reset and INT pins during the power-on initialization phase. See the diagram below for configuration methods and timings:

#### Timing for initial setting slave address to 0xBA/0xBB:

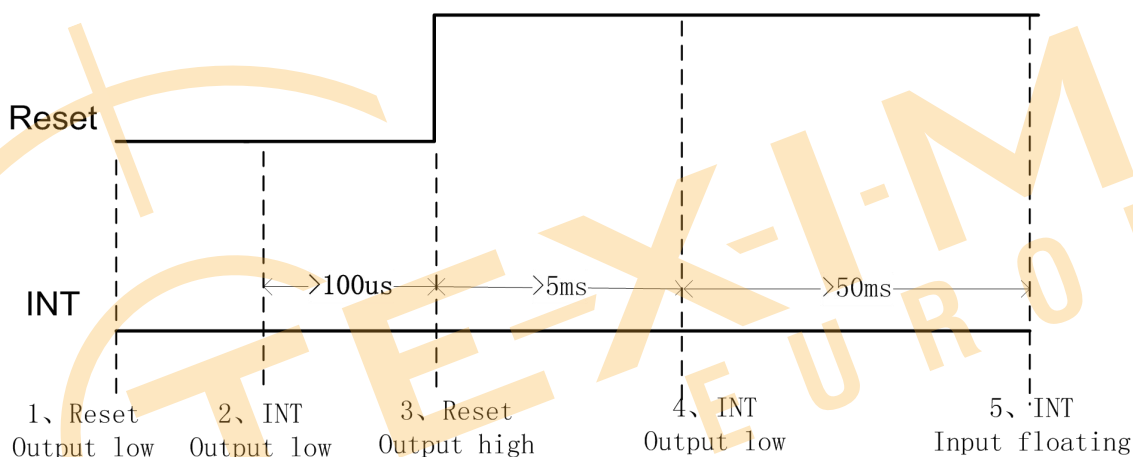

#### Timing for initial setting slave address to 0x28/0x29:

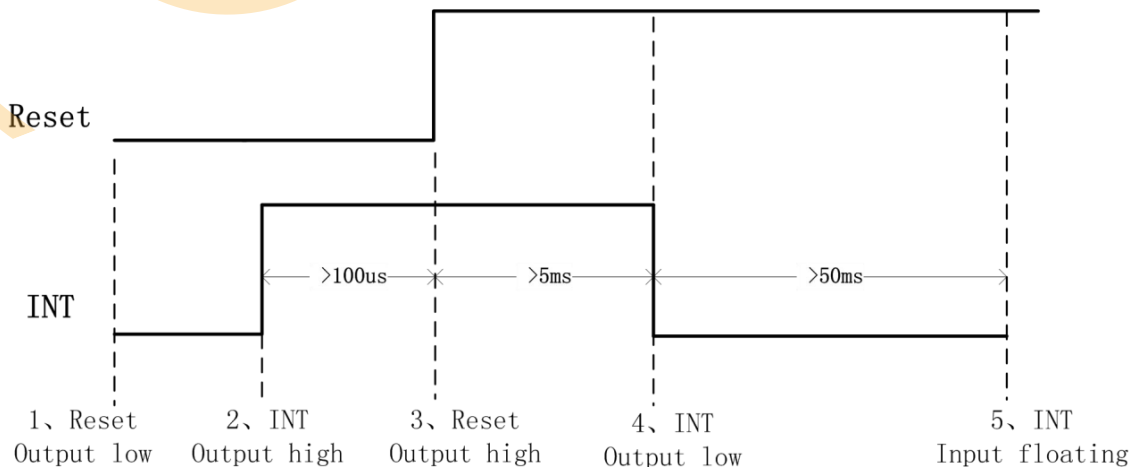

### 6.3.3 I2C Timing

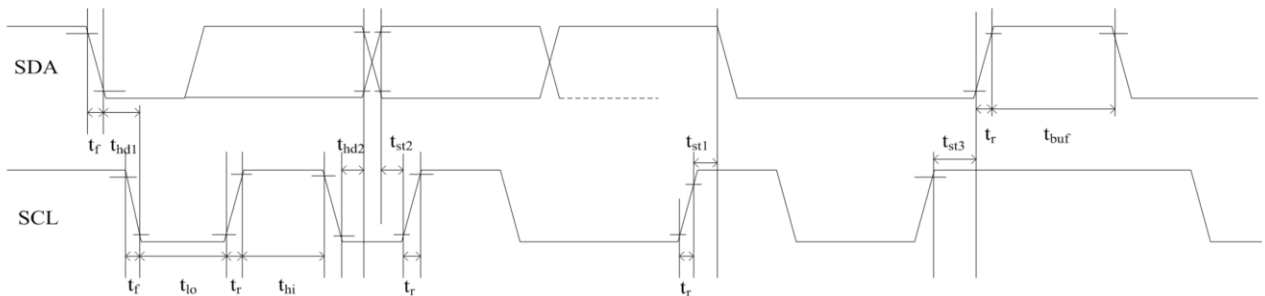

#### 3.3V communication interface, 400Kbps, pull up resistor is 2K ohm

Parameter	Symbol	Min.	Max.	Unit
SCL low period	$t_{io}$	1.3	-	us
SCL high period	$t_{hi}$	0.6	-	us
SCL setup time for Start condition	$t_{st1}$	0.6	-	us
SCL setup time for Stop condition	$t_{st3}$	0.6	-	us
SCL hold time for Start condition	$t_{hd1}$	0.6	-	us
SDA setup time	$t_{st2}$	0.1	-	us
SDA hold time	$t_{hd2}$	0	-	us

### 6.3.4 Data Transmission

(ex: slave address is 0xBA/0xBB)

Communication is always initiated by master, A high-to-low transition of SDA with SCL high is a All addressing signal are serially transmitted to and from on bus in 8-bit word. GT911 sends a "0" to acknowledge when the addressing word is 0xBA/BB (or 0x28/0x29 ).

This happens during the ninth clock cycle. If the slave address is not matched, GT911 will stay in idle state.

The data words are serially transmitted to and from in 9-bit formation: 8-bit data + 1-bit ACK or NACK sent by GT911. Data changes during SCL low periods & keeps valid during SCL high.

A low-to-high transition of SDA with SCL high is a stop condition.

### 6.3.5 Write Data to GT911

(ex: slave address is 0xBA/0xBB)



#### Write operations

Please check the above figure, master start the communication first, and then sends device address 0xBA preparing for a write operation.

After receiving ACK from GT911, master sends out 16-bit register address, and then the data word in 8-bit, which is going to be wrote into GT911.

The address pointer of GT911 will automatically increase one after one byte writing, so master can sequentially write in one operation. When operation finished, master stop the communication.

### 6.3.6 Read Data from GT911

(ex: slave address is 0xBA/0xBB)



#### Read operations

The diagram above is the timing sequence of the host reading data from GT911. First, the host issues a Start condition and sends 0xBA (address bits and R/W bit; R/W bit as 0 indicates Write operation) to the slave device.

After receiving ACK, the host sends the 16-bit register address (where reading starts) to the slave device. Then the host sets register addresses which need to be read.

Also after receiving ACK, the host issues the Start condition once again and sends 0xBB (Read Operation). After receiving ACK, the host starts to read data.

GT911 also supports continuous Read Operation and, by default, reads data continuously. Whenever receiving a byte of data, the host sends an ACK signal indicating successful reception. After receiving the last byte of data, the host sends a NACK signal followed by a STOP condition which terminates communication.

### 6.3.7 Coordinates Information

Addr	Access	bit7	bit6	bit5	bit4	bit3	bit2	bit1	bit0
0x814E	R/W	buffer status	large detect	Reserved		number of touch points			
0x814F	R	track id							
0x8150	R	point 1 x coordinate (low byte)							
0x8151	R	point 1 x coordinate (high byte)							
0x8152	R	point 1 y coordinate (low byte)							
0x8153	R	point 1 y coordinate (high byte)							
0x8154	R	Point 1 size (low byte)							
0x8155	R	point 1 size (high byte)							
0x8156	R	Reserved							

\* Addr = [Register\_H : Register\_L]

Buffer status, 1 = coordinate (or key) is ready for host to read; 0 = coordinate (or key) is not ready and data is not valid. After reading coordinates, host should configure this flag (or the entire byte) to 0 via I2C.

Large detect, 1 indicates there is large-area touch on TP.



## 7. Optical Characteristics

Item	Symbol	Condition	Min	Typ	Max	Unit
View Angle	(V) $\theta$	—	160	—	—	deg
	(H) $\phi$	—	160	—	—	deg
Contrast Ratio	CR	Dark	10,000:1	—	—	—
Response Time	T rise	—	—	10	—	$\mu$ s
	T fall	—	—	10	—	$\mu$ s
Display with 50% checkerboard Brightness			60	80	—	cd/m <sup>2</sup>
CIEx(White)		(CIE1931)	0.24	0.28	0.32	—
CIEy(White)		(CIE1931)	0.28	0.32	0.36	—

Note : 50% checkerboard means half of the display area turn on & half area turn off, shown as a checkerboard.

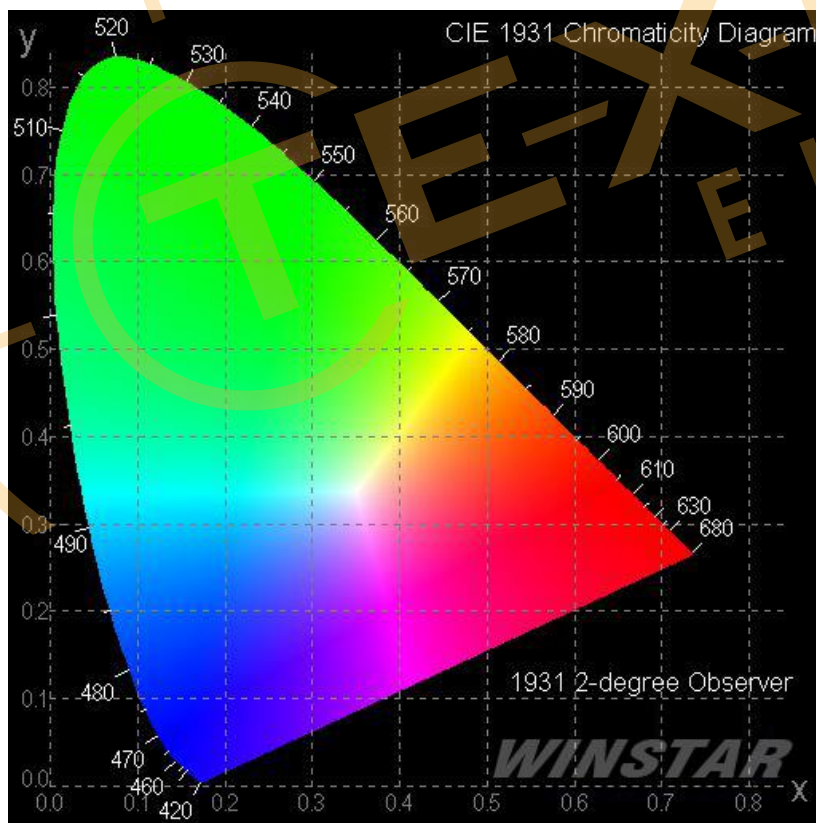

## 8.OLED Lifetime

ITEM	Conditions	Min	Typ	Remark
Operating Life Time	Ta=25°C / Initial 50% checkerboard brightness Typical Value	20,000 Hrs	—	Note

Note:

1. Lifetime is defined the amount of time when the luminance has decayed to <50% of the minimal brightness.
2. This analysis method uses life data obtained under accelerated conditions to extrapolate an estimated probability density function (*pdf*) for the product under normal use conditions.
3. Screen saving mode will extend OLED lifetime.
4. Lifetime is not guaranteed one but expected lifetime in normal condition.

## 9. Reliability

### Content of Reliability Test

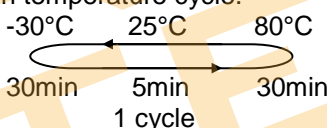
Environmental Test			
Test Item	Content of Test	Test Condition	Applicable Standard
High Temperature storage	Endurance test applying the high storage temperature for a long time.	80°C 240hrs	—
Low Temperature storage	Endurance test applying the low storage temperature for a long time.	-30°C 240hrs	—
High Temperature Operation	Endurance test applying the electric stress (Voltage & Current) and the thermal stress to the element for a long time.	70°C 240hrs	—
Low Temperature Operation	Endurance test applying the electric stress under low temperature for a long time.	-20°C 240hrs	—
High Temperature/ Humidity Storage	Endurance test applying the high temperature and high humidity storage for a long time.	60°C,90%RH 240hrs	—
High Temperature/ Humidity Operation	Endurance test applying the high temperature and high humidity Operation for a long time.	60°C,90%RH 120hrs	—
Temperature Cycle	Endurance test applying the low and high temperature cycle. 	-30°C /80°C 30 cycles	—
Mechanical Test			
Vibration test	Endurance test applying the vibration during transportation and using.	Frequency:10~55Hz amplitude:1.5mm Time:0.5hrs/axis Test axis:X,Y,Z	—
Others			
Static electricity test	Endurance test applying the electric stress to the finished product housing.	Air Discharge model ±4kv,10 times	—

\*\*\* Supply voltage for OLED system =Operating voltage at 25°C

### **Test and measurement conditions**

1. All measurements shall not be started until the specimens attain to temperature stability.  
After the completion of the described reliability test, the samples were left at room temperature for 2 hrs prior to conducting the functional test at  $23\pm 5^{\circ}\text{C}$ ;  $55\pm 15\%$  RH.
2. All-pixels on/off exchange is used as operation test pattern.
3. The degradation of Polarizer are ignored for High Temperature storage, High Temperature/ Humidity Storage, Temperature Cycle.
4. No Condensation.

### **Evaluation criteria**

1. The function test is OK.
2. No observable defects.
3. Luminance:  $> 50\%$  of initial value.
4. Current consumption: within  $\pm 50\%$  of initial value.

### **APPENDIX:**

#### **RESIDUE IMAGE**

Because the pixels are lighted in different time, the luminance of active pixels may reduce or differ from inactive pixels. Therefore, the residue image will occur. To avoid the residue image, every pixel needs to be lighted up uniformly.



# 10. Inspection specification

## Inspection Standard:

MIL-STD-105E table normal inspection single sample level II.

## Definition

- 1 Major defect : The defect that greatly affect the usability of product.
- 2 Minor defect : The other defects, such as cosmetic defects, etc.

Definition of inspection zone:

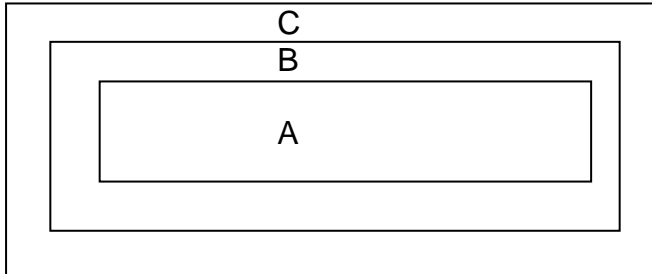

Zone A: Active Area

Zone B: Viewing Area except Zone A

Zone C: Outside Viewing Area

Note: As a general rule, visual defects in Zone C are permissible, when it is no trouble of quality and assembly to customer`s product.

## Inspection Methods

- 1 The general inspection : Under fluorescent light illumination: 750~1500 Lux, about 30cm viewing distance, within 45° viewing angle, under 25±5°C.
- 2 The luminance and color coordinate inspection : By SR-3 or BM-7 or the equal equipments, in the dark room, under 25±5°C.

NO	Item	Criterion	AQL
01	Electrical Testing	1.1 Missing vertical, horizontal segment, segment contrast defect. 1.2 Missing character , dot or icon. 1.3 Display malfunction. 1.4 No function or no display. 1.5 Current consumption exceeds product specifications. 1.6 OLED viewing angle defect. 1.7 Mixed product types. 1.8 Contrast defect.	0.65
02	Black or white spots on OLED (display only)	2.1 White and black spots on display $\leq 0.25\text{mm}$ , no more than three white or black spots present. 2.2 Densely spaced: No more than two spots or lines within 3mm.	2.5

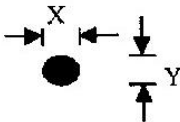
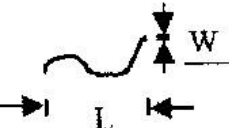
NO	Item	Criterion	AQL																			
03	OLED black spots, white spots, contamination (non-display)	3.1 Round type : As following drawing $\Phi = (x + y) / 2$  <table border="1" data-bbox="738 279 1401 525"> <thead> <tr> <th>SIZE</th> <th>Acceptable QTY</th> <th>Zone</th> </tr> </thead> <tbody> <tr> <td><math>\Phi \leq 0.10</math></td> <td>ignore</td> <td>A+ B</td> </tr> <tr> <td><math>0.10 &lt; \Phi \leq 0.20</math></td> <td>2</td> <td>A+ B</td> </tr> <tr> <td><math>0.20 &lt; \Phi \leq 0.25</math></td> <td>1</td> <td>A+ B</td> </tr> <tr> <td><math>0.25 &lt; \Phi</math></td> <td>0</td> <td>A+ B</td> </tr> </tbody> </table>	SIZE	Acceptable QTY	Zone	$\Phi \leq 0.10$	ignore	A+ B	$0.10 < \Phi \leq 0.20$	2	A+ B	$0.20 < \Phi \leq 0.25$	1	A+ B	$0.25 < \Phi$	0	A+ B	2.5				
		SIZE	Acceptable QTY	Zone																		
$\Phi \leq 0.10$	ignore	A+ B																				
$0.10 < \Phi \leq 0.20$	2	A+ B																				
$0.20 < \Phi \leq 0.25$	1	A+ B																				
$0.25 < \Phi$	0	A+ B																				
		3.2 Line type : (As following drawing)  <table border="1" data-bbox="609 884 1401 1129"> <thead> <tr> <th>Length</th> <th>Width</th> <th>Acceptable QTY</th> <th>Zone</th> </tr> </thead> <tbody> <tr> <td>---</td> <td><math>W \leq 0.02</math></td> <td>ignore</td> <td>A+B</td> </tr> <tr> <td><math>L \leq 3.0</math></td> <td><math>0.02 &lt; W \leq 0.03</math></td> <td rowspan="2">2</td> <td>A+B</td> </tr> <tr> <td><math>L \leq 2.5</math></td> <td><math>0.03 &lt; W \leq 0.05</math></td> <td>A+B</td> </tr> <tr> <td>---</td> <td><math>0.05 &lt; W</math></td> <td>As round type</td> <td></td> </tr> </tbody> </table>	Length	Width	Acceptable QTY	Zone	---	$W \leq 0.02$	ignore	A+B	$L \leq 3.0$	$0.02 < W \leq 0.03$	2	A+B	$L \leq 2.5$	$0.03 < W \leq 0.05$	A+B	---	$0.05 < W$	As round type		2.5
Length	Width	Acceptable QTY	Zone																			
---	$W \leq 0.02$	ignore	A+B																			
$L \leq 3.0$	$0.02 < W \leq 0.03$	2	A+B																			
$L \leq 2.5$	$0.03 < W \leq 0.05$		A+B																			
---	$0.05 < W$	As round type																				
04	Polarizer bubbles /Dent	4.1 If bubbles are visible, judge using black spot specifications, not easy to find, must check in specify direction.  4.2 The polarizer dent follows this specification. <table border="1" data-bbox="730 1287 1401 1535"> <thead> <tr> <th>Size <math>\Phi</math></th> <th>Acceptable QTY</th> <th>Zone</th> </tr> </thead> <tbody> <tr> <td><math>\Phi \leq 0.20</math></td> <td>ignore</td> <td>A+B</td> </tr> <tr> <td><math>0.20 &lt; \Phi \leq 0.50</math></td> <td>3</td> <td>A+B</td> </tr> <tr> <td><math>0.50 &lt; \Phi \leq 1.00</math></td> <td>2</td> <td>A+B</td> </tr> <tr> <td><math>1.00 &lt; \Phi</math></td> <td>0</td> <td>A+B</td> </tr> <tr> <td>Total QTY</td> <td>3</td> <td></td> </tr> </tbody> </table>	Size $\Phi$	Acceptable QTY	Zone	$\Phi \leq 0.20$	ignore	A+B	$0.20 < \Phi \leq 0.50$	3	A+B	$0.50 < \Phi \leq 1.00$	2	A+B	$1.00 < \Phi$	0	A+B	Total QTY	3		2.5	
Size $\Phi$	Acceptable QTY	Zone																				
$\Phi \leq 0.20$	ignore	A+B																				
$0.20 < \Phi \leq 0.50$	3	A+B																				
$0.50 < \Phi \leq 1.00$	2	A+B																				
$1.00 < \Phi$	0	A+B																				
Total QTY	3																					
05	Scratches	Follow NO.3 OLED black spots, white spots, contamination.																				

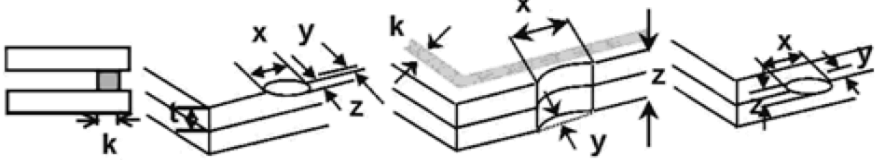
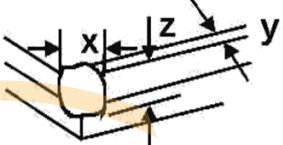
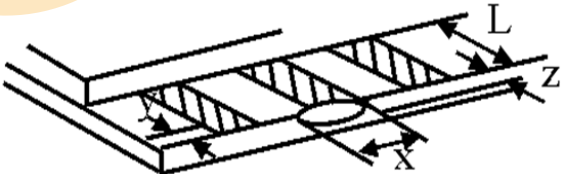
NO	Item	Criterion	AQL																		
06	Chipped glass	<p>Symbols Define:                      x: Chip length      y: Chip width      z: Chip thickness                      k: Seal width      t: Glass thickness      a: OLED side length                      L: Electrode pad length:                      6.1 General glass chip :                      6.1.1 Chip on panel surface and crack between panels:</p>  <table border="1" data-bbox="472 583 1377 709"> <tr> <td>z: Chip thickness</td> <td>y: Chip width</td> <td>x: Chip length</td> </tr> <tr> <td><math>Z \leq 1/2t</math></td> <td>Not over viewing area</td> <td><math>x \leq 1/8a</math></td> </tr> <tr> <td><math>1/2t &lt; z \leq 2t</math></td> <td>Not exceed 1/3k</td> <td><math>x \leq 1/8a</math></td> </tr> </table> <p>⊙ If there are 2 or more chips, x is total length of each chip.</p> <p>6.1.2 Corner crack:</p>  <table border="1" data-bbox="472 976 1395 1102"> <tr> <td>z: Chip thickness</td> <td>y: Chip width</td> <td>x: Chip length</td> </tr> <tr> <td><math>Z \leq 1/2t</math></td> <td>Not over viewing area</td> <td><math>x \leq 1/8a</math></td> </tr> <tr> <td><math>1/2t &lt; z \leq 2t</math></td> <td>Not exceed 1/3k</td> <td><math>x \leq 1/8a</math></td> </tr> </table> <p>⊙ If there are 2 or more chips, x is the total length of each chip.</p>	z: Chip thickness	y: Chip width	x: Chip length	$Z \leq 1/2t$	Not over viewing area	$x \leq 1/8a$	$1/2t < z \leq 2t$	Not exceed 1/3k	$x \leq 1/8a$	z: Chip thickness	y: Chip width	x: Chip length	$Z \leq 1/2t$	Not over viewing area	$x \leq 1/8a$	$1/2t < z \leq 2t$	Not exceed 1/3k	$x \leq 1/8a$	2.5
z: Chip thickness	y: Chip width	x: Chip length																			
$Z \leq 1/2t$	Not over viewing area	$x \leq 1/8a$																			
$1/2t < z \leq 2t$	Not exceed 1/3k	$x \leq 1/8a$																			
z: Chip thickness	y: Chip width	x: Chip length																			
$Z \leq 1/2t$	Not over viewing area	$x \leq 1/8a$																			
$1/2t < z \leq 2t$	Not exceed 1/3k	$x \leq 1/8a$																			
06	Glass crack	<p>Symbols :                      x: Chip length      y: Chip width      z: Chip thickness                      k: Seal width      t: Glass thickness      a: OLED side length                      L: Electrode pad length                      6.2 Protrusion over terminal :                      6.2.1 Chip on electrode pad :</p>  <table border="1" data-bbox="472 1640 1377 1724"> <tr> <td>y: Chip width</td> <td>x: Chip length</td> <td>z: Chip thickness</td> </tr> <tr> <td><math>y \leq 0.5\text{mm}</math></td> <td><math>x \leq 1/8a</math></td> <td><math>0 &lt; z \leq t</math></td> </tr> </table>	y: Chip width	x: Chip length	z: Chip thickness	$y \leq 0.5\text{mm}$	$x \leq 1/8a$	$0 < z \leq t$	2.5												
y: Chip width	x: Chip length	z: Chip thickness																			
$y \leq 0.5\text{mm}$	$x \leq 1/8a$	$0 < z \leq t$																			

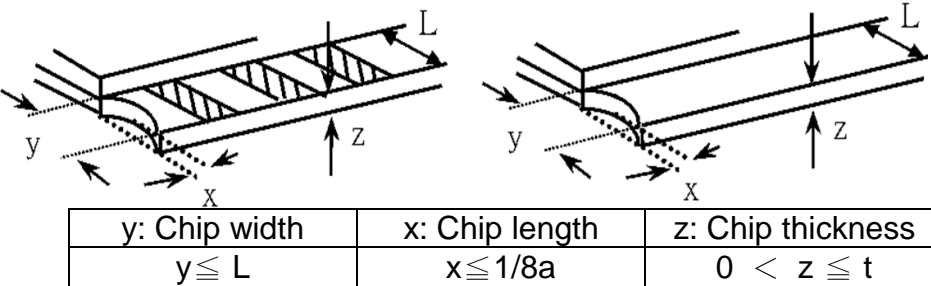
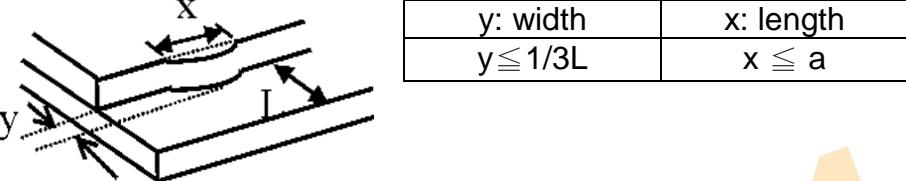
NO	Item	Criterion	AQL
06	Glass crack	<p>6.2.2 Non-conductive portion:</p>  <p>⊙ If the chipped area touches the ITO terminal, over 2/3 of the ITO must remain and be inspected according to electrode terminal specifications.</p> <p>⊙ If the product will be heat sealed by the customer, the alignment mark not be damaged.</p> <p>6.2.3 Substrate protuberance and internal crack.</p> 	2.5
07	Cracked glass	The OLED with extensive crack is not acceptable.	2.5
08	Backlight elements	<p>8.1 Illumination source flickers when lit.</p> <p>8.2 Spots or scratched that appear when lit must be judged. Using OLED spot, lines and contamination standards.</p> <p>8.3 Backlight doesn't light or color wrong.</p>	0.65 2.5 0.65
09	Bezel	<p>9.1 Bezel may not have rust, be deformed or have fingerprints, stains or other contamination.</p> <p>9.2 Bezel must comply with job specifications.</p>	2.5 0.65
10	PCB , COB	<p>10.1 COB seal may not have pinholes larger than 0.2mm or contamination.</p> <p>10.2 COB seal surface may not have pinholes through to the IC.</p> <p>10.3 The height of the COB should not exceed the height indicated in the assembly diagram.</p> <p>10.4 There may not be more than 2mm of sealant outside the seal area on the PCB. And there should be no more than three places.</p> <p>10.5 No oxidation or contamination PCB terminals.</p> <p>10.6 Parts on PCB must be the same as on the production characteristic chart. There should be no wrong parts, missing parts or excess parts.</p> <p>10.7 The jumper on the PCB should conform to the product characteristic chart.</p> <p>10.8 If solder gets on bezel tab pads, OLED pad, zebra pad or screw hold pad, make sure it is smoothed down.</p>	2.5 2.5 0.65 2.5 2.5 0.65 0.65 2.5

NO	Item	Criterion	AQL
11	Soldering	11.1 No un-melted solder paste may be present on the PCB. 11.2 No cold solder joints, missing solder connections, oxidation or icicle. 11.3 No residue or solder balls on PCB. 11.4 No short circuits in components on PCB.	2.5 2.5 2.5 0.65
12	General appearance	12.1 No oxidation, contamination, curves or, bends on interface Pin (OLB) of TCP. 12.2 No cracks on interface pin (OLB) of TCP. 12.3 No contamination, solder residue or solder balls on product. 12.4 The IC on the TCP may not be damaged, circuits. 12.5 The uppermost edge of the protective strip on the interface pin must be present or look as if it cause the interface pin to sever. 12.6 The residual rosin or tin oil of soldering (component or chip component) is not burned into brown or black color. 12.7 Sealant on top of the ITO circuit has not hardened. 12.8 Pin type must match type in specification sheet. 12.9 OLED pin loose or missing pins. 12.10 Product packaging must the same as specified on packaging specification sheet. 12.11 Product dimension and structure must conform to product specification sheet.	2.5 0.65 2.5 2.5 2.5 2.5 2.5 0.65 0.65 0.65 0.65

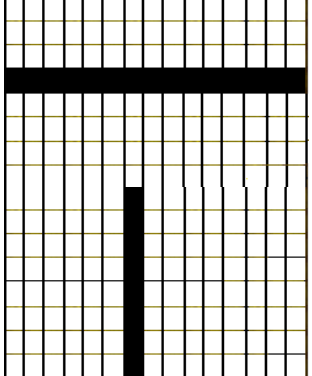
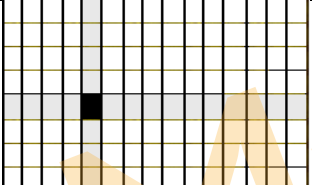
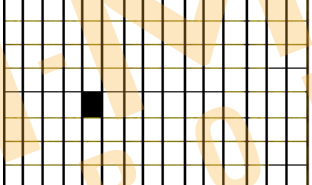
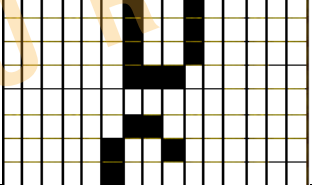
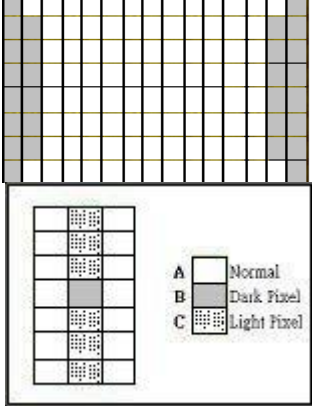
Check Item	Classification	Criteria
No Display	Major	
Missing Line	Major	
Pixel Short	Major	
Dark Pixel	Major	
Wrong Display	Major	
Un-uniform $B/A \times 100\% < 70\%$ $A/C \times 100\% < 70\%$	Major	

# 11. Precautions in use of OLED Modules

## Modules

- (1) Avoid applying excessive shocks to module or making any alterations or modifications to it.
- (2) Don't make extra holes on the printed circuit board, change the components or modify its shape of OLED display module.
- (3) Don't disassemble the OLED display module.
- (4) Do not apply input signals while the logic power is off.
- (5) Don't operate it above the absolute maximum rating.
- (6) Don't drop, bend or twist OLED display module.
- (7) Soldering: only to the I/O terminals.
- (8) Hot-Bar FPC soldering condition: 280~350C, less than 5 seconds.
- (9) Winstar has the right to change the passive components (Resistors, capacitors and other passive components will have different appearance and color caused by the different supplier.) and change the PCB Rev. (In order to satisfy the supplying stability, management optimization and the best product performance...etc, under the premise of not affecting the electrical characteristics and external dimensions, Winstar have the right to modify the version.)
- (10) Winstar has the right to upgrade or modify the product function.
- (11) For COG & COF structure OLED products, customers should reserve VCC (VPP) adjustment function or software update function when designing OLED supporting circuit. (The progress of OLED light-emitting materials will increase the conversion efficiency and the brightness. The brightness can be adjusted if necessary).

### 11.1. Handling Precautions

- (1) Since the display panel is being made of glass, do not apply mechanical impacts such as dropping from a high position.
- (2) If the display panel is broken by some accident and the internal organic substance leaks out, be careful not to inhale nor lick the organic substance.
- (3) If pressure is applied to the display surface or its neighborhood of the OLED display module, the cell structure may be damaged. So, be careful not to apply pressure to these sections.
- (4) The polarizer covering the surface of the OLED display module is soft and easily scratched.
- (5) When the surface of the polarizer of the OLED display module has soil, clean the surface. It takes advantage by using following adhesion tape.
  - \* Scotch Mending Tape No. 810 or an equivalentNever try to breathe upon the soiled surface nor wipe the surface using cloth containing solvent such as ethyl alcohol, since the surface of the polarizer will become cloudy. Also, pay attention that the following liquid and solvent may spoil the polarizer:
  - \* Water
  - \* Ketone
  - \* Aromatic Solvents
- (6) Protection film is being applied to the surface of the display panel and removes the protection film before assembling it. At this time, if the OLED display module has been stored for a long period of time, residue adhesive material of the protection film may remain on the surface of the display panel after removed of the film. In such case, remove the residue material by the method introduced in the above Section 5.
- (7) Do not touch the following sections whenever possible while handling the OLED display modules.
  - \* Pins and electrodes
  - \* Pattern layouts such as the TCP & FPC

- (8) Hold OLED display module very carefully when placing OLED display module into the System housing. Do not apply excessive stress or pressure to OLED display module. And, do not over bend the film with electrode pattern layouts. These stresses will influence the display performance. Also, secure sufficient rigidity for the outer cases.

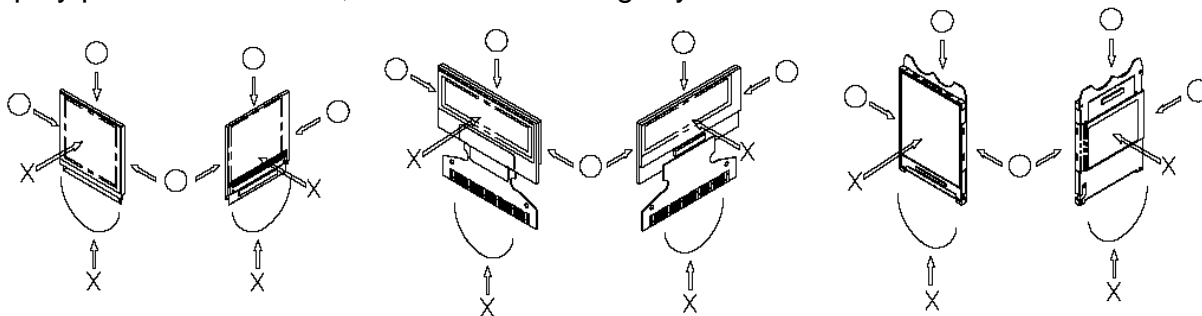

- (9) Do not apply stress to the LSI chips and the surrounding molded sections.
- (10) Pay sufficient attention to the working environments when handing OLED display modules to prevent occurrence of element breakage accidents by static electricity.
- \* Be sure to make human body grounding when handling OLED display modules.
  - \* Be sure to ground tools to use or assembly such as soldering irons.
  - \* To suppress generation of static electricity, avoid carrying out assembly work under dry environments.
  - \* Protective film is being applied to the surface of the display panel of the OLED display module. Be careful since static electricity may be generated when exfoliating the protective film.

## 11.2. Storage Precautions

- (1) When storing OLED display modules, put them in static electricity preventive bags to avoid be directly exposed to sun or lights of fluorescent lamps. And, also, place in the temperature  $25\pm 5^{\circ}\text{C}$  and Humidity below 65% RH. (We recommend you to store these modules in the packaged state when they were shipped from Winstar. At that time, be careful not to let water drops adhere to the packages or bags.)
- (2) When the OLED display module is being dewed or when it is placed under high temperature or high humidity environments, the electrodes may be corroded if electric current is applied. Please store it in clean environment.

## 11.3. Designing Precautions

- (1) The absolute maximum ratings are the ratings which cannot be exceeded for OLED display module, and if these values are exceeded, OLED display module may be damaged.
- (2) To prevent occurrence of malfunctioning by noise, pay attention to satisfy the VIL and VIH specification and to make the signal line cable as short as possible.
- (3) We recommend you to install excess current preventive unit (fuses, etc.) to the power circuit (VDD / VCC). (Recommend value: 0.5A)
- (4) Pay sufficient attention to avoid occurrence of mutual noise interference with the nearby devices.
- (5) As for EMI, take necessary measures on the equipment side basically.
- (6) If the power supplied to the OLED display module is forcibly shut down by such errors as taking out the main battery while the OLED display panel is in operation, we cannot guarantee the quality of this OLED display module.
- \* Connection (contact) to any other potential than the above may lead to rupture of the IC.
- (7) If this OLED driver is exposed to light, malfunctioning may occur and semiconductor elements may change their characteristics.

- (8) The internal status may be changed, if excessive external noise enters into the module. Therefore, it is necessary to take appropriate measures to suppress noise generation or to protect module from influences of noise on the system design.
- (9) We recommend you to make periodical refreshment of the operation statuses (re-setting of the commands and re-transference of the display data) to cope with catastrophic noise.
- (10) It's pretty common to use "Screen Saver" to extend the lifetime and Don't use the same image for long time in real application. When an OLED display module is operated for a long of time with fixed pattern, an afterimage or slight contrast deviation may occur.
- (11) The limitation of FPC and Film bending.

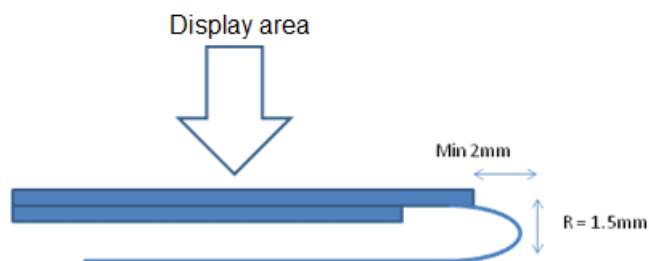

- (12) The module should be fixed balanced into the housing, or the module may be twisted.

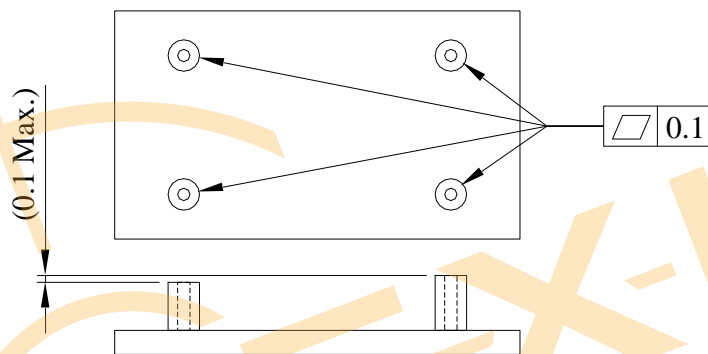

- (13) Please heat up a little the tape sticking on the components when removing it; otherwise the components might be damaged.

#### 11.4. Precautions when disposing of the OLED display modules

- (1) Request the qualified companies to handle industrial wastes when disposing of the OLED display modules. Or, when burning them, be sure to observe the environmental and hygienic laws and regulations.

## **Disclaimer**

ALL PRODUCTS, PRODUCT SPECIFICATIONS AND DATA ARE SUBJECT TO CHANGE WITHOUT NOTICE TO IMPROVE RELIABILITY, FUNCTION OR DESIGN OR OTHERWISE.

Texim Europe B.V. its affiliates, agents, and employees, and all persons acting on its or their behalf (collectively, "Texim"), disclaim any and all liability for any errors, inaccuracies or incompleteness contained in any datasheet or in any other disclosure relating to any product.

Texim makes no warranty, representation or guarantee regarding the suitability of the products for any particular purpose or the continuing production of any product.

It is the customer's responsibility to validate that a particular product with the properties described in the product specification is suitable for use in a particular application.

Parameters provided in datasheets and / or specifications may vary in different applications and performance may vary over time.

All operating parameters, including typical parameters, must be validated for each customer application by the customer's technical experts.

Please contact us if you have any questions about the contents of the datasheet.

This may not be the latest version of the datasheet. Please check with us if a later version is available.

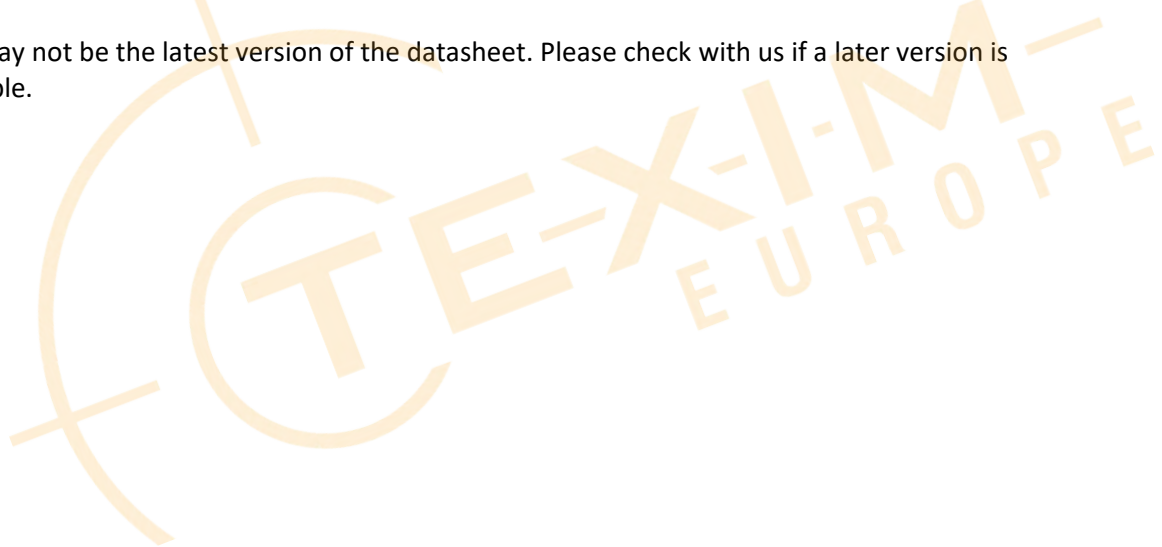



## Headquarters & Warehouse

Elektrostraat 17  
 NL-7483 PG Haaksbergen  
 The Netherlands

T: +31 (0)53 573 33 33  
 E: info@texim-europe.com  
 Homepage: www.texim-europe.com



### The Netherlands

Elektrostraat 17  
 NL-7483 PG Haaksbergen

T: +31 (0)53 573 33 33  
 E: nl@texim-europe.com



### Belgium

Zuiderlaan 14, box 10  
 B-1731 Zellik

T: +32 (0)2 462 01 00  
 E: belgium@texim-europe.com



### UK & Ireland

St Mary's House, Church Lane  
 Carlton Le Moorland  
 Lincoln LN5 9HS

T: +44 (0)1522 789 555  
 E: uk@texim-europe.com



### Germany

Bahnhofstrasse 92  
 D-25451 Quickborn

T: +49 (0)4106 627 07-0  
 E: germany@texim-europe.com



### Germany

Martin-Kollar-Strasse 9  
 D-81829 München

T: +49 (0)89 436 086-0  
 E: muenchen@texim-europe.com



### Austria

Warwitzstrasse 9  
 A-5020 Salzburg

T: +43 (0)662 216 026  
 E: austria@texim-europe.com



### Nordic

Stockholmsgade 45  
 2100 Copenhagen

T: +45 88 20 26 30  
 E: nordic@texim-europe.com



### Italy

Martin-Kollar-Strasse 9  
 D-81829 München

T: +49 (0)89 436 086-0  
 E: italy@texim-europe.com